

NEW

YOKOGAWA 

Handy Calibrator

CA150

Multi-functional Hand-held Calibrator

- Highly accurate within 0.02% of the DC voltage range for source and measure
- Source and measurement can be performed simultaneously.
- Vertical body with large-screen display
- Loop power supply function (24 VDC at a load of max 22 mA)
It is possible to measure current in the mA range while supplying power.
- Sink function
- Sweep functions that allow 3 types of continuous outputs:
Step sweep function
Linear sweep function
Program sweep function



Yokogawa Meters & Instruments Corporation

Bulletin CA150-E

CA150

Handy Cal

Multi-functional and high-precision calibrator that can be used to calibrate and test industrial process devices and various electronics equipment

Functions/Features

Vertical hand-held calibrator

Easy-to-hold vertical body is designed to make it intuitively easy to operate, as individual functions are accessed directly by pressing assigned keys.

Using the main body case (model No. 93027) (sold separately), you can hang CA150 to your body or a handrail to keep it handy.

Simultaneous source and measurement for process devices

In conventional calibration applications, multiple devices such as a standard generator, dial resistor and multi-meter were required. Now with a single CA150 unit, it is possible to perform operation check at regular inspection and maintenance of thermocouples, RTDs and instruments, as well as maintenance and equipment diagnosis of process devices such as transmitters, thermostats and signal converters.

Loop power supply function

It is possible to measure generated current signals while supplying loop power 24 VDC from a two-wire type transmitter (up to 22 mA DC).

Highly accurate and multi-functional source and measurement

High accuracy: 0.02% for the source unit and 0.02% for the measurement unit

Source and Measurement functions: DCV voltage, DC mA, ohm, frequency and temperature (thermocouple, RTD) and 24 VDC power supply function for transmitters



Two-wire Type Transmitter Applications

Two-wire type transmitter (measurement function) application

Loop check function

Measures mA DC signals output while supplying transmitter power at 24 VDC.

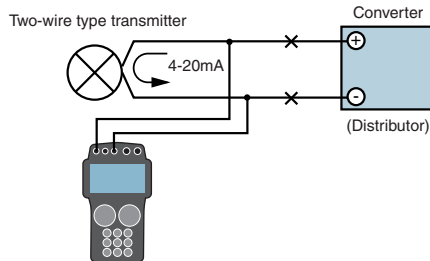

Two-wire type transmitter (source function) application

Sink function

Receives current (Sink) from the power supply at voltages of up to 28 VDC and transmits mA DC signals to the loop.

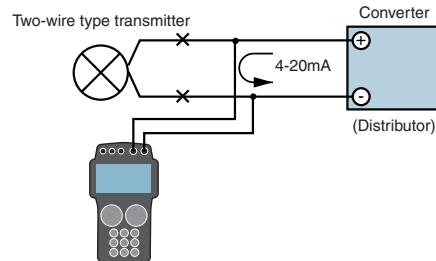

Memory Functions

Setting memory

This function saves/loads setting conditions.

Up to 21 data items can be stored.

Settings for (source/measurement) functions, ranges, generated values/measured values as well as setting mode conditions can be stored.

Data memory

This function saves source and measure values displayed.

Up to 100 data items can be stored.

Storage date/time, (source/measurement) functions, ranges and generated values/measured values can be stored. Stored data can be checked on the display of the main unit as well as via communication.

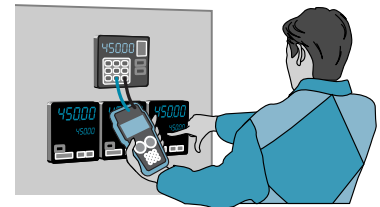

Convenient Functions Useful in Field Tests

Sweep Functions (Automatic Output Functions)

Step sweep function

This function changes the output in a staircase (step) pattern at fixed intervals.

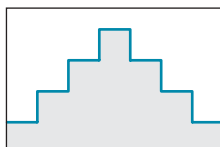

Step sweep

Linear sweep function

This function increases (or decreases) the output linearly with respect to the generated value.

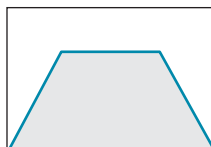

Linear sweep

Program sweep function

This function outputs source setting values stored by the data memory function sequentially in the order they are stored in the memory.

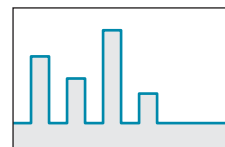

Program sweep

Specifications

Source Unit

Accuracy=±(% of setting+μV, mV, μA, Ω and °C) at 23°C±5°C

	Range	Resolution	Source range	Accuracy	Remark	
DC voltage	100mV	1uV	0 to ±110.000mV	±(0.02%+10uV)	Output resistance: Approx. 6.5Ω	
	1V	10uV	0 to ±1.10000V	±(0.02%+0.05mV)	Maximum output: 10 mA, output resistance: Approx. 30 mΩ	
	10V	0.1mV	0 to ±11.0000V	±(0.02%+0.5mV)	Maximum output: 10 mA, output resistance: Approx. 30 mΩ	
	30V	10mV	0 to ±30.00V	±(0.02%+10mV)	Maximum output: 10 mA	
DC current mA SINK	20mA	1uA	0 to +22.000mA	±(0.025%+3uA)	Maximum load: 24 V	
	20mASINK	1uA	0 to -22.000mA	±(0.025%+6uA)	External power supply: 5 to 28 V	
OHM	500Ω	0.01Ω	0 to 550.00Ω	±(0.02%+0.1Ω)	Excitation current: 1 to 5 mA or maximum output: 2 V ²	
	5kΩ	0.1Ω	0 to 5.5000kΩ	±(0.05%+1.5Ω)	Excitation current: 0.1 to 0.5 mA or maximum output: 2 V	
	50kΩ	1Ω	0 to 55.000kΩ	±(0.1%+50Ω)	Excitation current: 0.01 to 0.1 mA or maximum output: 2 V	
RTD *1	PT100	0.1°C	-200.0 to 850.0°C	±(0.025%+0.3°C)	Excitation current: 1 to 5 mA *2	
	JPT100		-200.0 to 500.0°C			
Thermocouple *3	K	0.1°C	-200.0 to -100.0°C	±(0.02%+0.8°C)	*2 Excitation current Is: In the case of 0.1 mA to 1 mA or less, {0.05/Is (mA)} (Ω) or add {0.12/Is (mA)} (°C) *3 RJC accuracy is not included in the thermocouple generation accuracy. Reference temperature compensation is carried out by the separately sold RJ sensor. To compensate for the reference contact temperature in the output, add the RJ sensor accuracy. Output compensation: Every 10 seconds RJ sensor specifications Measured temperature range: -10 to 50°C Accuracy: 18 to 28°C: ±0.5°C (combination with the main unit) Other than above: ±1.0°C (combination with the main unit)	
			-100.0 to 1372.0°C			±(0.02%+0.5°C)
			-200.0 to -100.0°C			±(0.02%+0.6°C)
			-100.0 to 1000.0°C			±(0.02%+0.4°C)
			-200.0 to -100.0°C			±(0.02%+0.7°C)
			-100.0 to 1200.0°C			±(0.02%+0.4°C)
	E	1°C	-200.0 to -100.0°C	±(0.02%+0.5°C)		
			-100.0 to 400.0°C			±(0.02%+0.5°C)
			-200.0 to 0°C			±(0.02%+1.0°C)
	J	1°C	0.0 to 1300.0°C	±(0.02%+0.5°C)		
			-200.0 to 900.0°C			±(0.02%+0.5°C)
			-200.0 to 0°C			±(0.02%+0.7°C)
	T	1°C	0 to 400.0°C	±(0.02%+0.5°C)		
0 to 100°C			±(0.02%+2°C)			
100 to 1768°C			±(0.02%+1.2°C)			
N	1°C	0 to 100°C	±(0.02%+2°C)			
		100 to 1768°C		±(0.02%+1.2°C)		
		600 to 1000°C		±(0.02%+1.5°C)		
L	1°C	1000 to 1820°C	±(0.02%+1°C)			
		0 to 100°C		±(0.02%+0.5°C)		
		0 to 400.0°C		±(0.02%+0.7°C)		
U	1°C	0 to 100°C	±(0.02%+2°C)			
		100 to 1768°C		±(0.02%+1.2°C)		
		600 to 1000°C		±(0.02%+1.5°C)		
R	1°C	1000 to 1820°C	±(0.02%+1°C)			
		0 to 100°C		±(0.02%+0.5°C)		
		0 to 400.0°C		±(0.02%+0.7°C)		
S	1°C	0 to 100°C	±(0.02%+2°C)			
		100 to 1768°C		±(0.02%+1.2°C)		
		600 to 1000°C		±(0.02%+1.5°C)		
B	1°C	1000 to 1820°C	±(0.02%+1°C)			
		0 to 100°C		±(0.02%+0.5°C)		
		0 to 400.0°C		±(0.02%+0.7°C)		
Frequency /pulse	100Hz	0.01Hz	1.00 to 110.00Hz	±0.05Hz	Output voltage: +0.1 V to +11 V (Zero-base waveform) Amplitude accuracy: ±10% Maximum load current: 10 mA Pulse cycle: 1 to 60000 cycles *4	
	1000Hz	0.1Hz	90.0 to 1100.0Hz	±0.5Hz		
	10kHz	0.1kHz	0.9kHz to 11.0kHz	±0.1kHz		
	50kHz	1kHz	9kHz to 50kHz	±1kHz		
	CPM	0.1CPM	1.0 to 1100.0CPM	±0.5CPM		
	CPM	0.1CPM	1.0 to 1100.0CPM	±0.5CPM		

Temperature coefficient: Accuracy above x (1/10)/°C

The temperature coefficient is added in the ranges from 0 to 18°C and from 28 to 40°C

Measurement Unit

Accuracy=±(% of reading+μV, mV, μA, Ω or dgt(digit)) at 23°C±5°C

	Range	Resolution	Measurement range	Accuracy	Remark	
DC voltage	500mV	10uV	0 to ±500.00 mV	±(0.02%+50uV)	Input resistance: 1000 MΩ or more	
	5V	0.1mV	0 to ±5.0000V	±(0.02%+0.5mV)	Input resistance: Approx. 1 MΩ	
	35V	1mV	0 to ±35.000V	±(0.025%+5mV)		
DC current	20mA	1uA	0 to ±20.000mA	±(0.025%+4uA)	Input resistance: Approx. 20Ω or less	
	100mA	10uA	0 to ±100.00mA	±(0.04%+30uA)		
OHM	500Ω	0.01Ω	0 to 500.00Ω	±(0.055%+0.075Ω)	Measurement current: Approx. 1 mA	
	5kΩ	0.1Ω	0 to 5.0000kΩ	±(0.055%+0.75Ω)	Measurement current: Approx. 100 μA	
	50kΩ	1Ω	0 to 50.000kΩ	±(0.055%+10Ω)	Measurement current: Approx. 10 μA	
RTD *5	PT100	0.1°C	-200.0 to 850.0°C	±(0.05%+0.6°C)	*5 At three-wire type measurement	
	JPT100		-200.0 to 500.0°C			
Thermocouple	K	0.1°C	-200.0 to 1372.0°C	±(0.05%+1.5°C)/-100°C or more	A temperature coefficient is added if the display of the temperature monitor is outside the range of 18 to 28°C.	
			-200.0 to 1000.0°C			±(0.05%+2°C)/-100°C or less
			-200.0 to 1200.0°C			±(0.05%+2°C)/100°C or more
			-200.0 to 400.0°C			±(0.05%+3°C)/100°C or less
			-200.0 to 1300.0°C			±(0.05%+3°C)/100°C or less
			-200.0 to 900.0°C			±(0.05%+3°C)/100°C or less
	R	1°C	0 to 1768°C	±(0.05%+2°C)/100°C or more		
			0 to 1768°C	±(0.05%+3°C)/100°C or less		
Pulse	100Hz	0.01Hz	1.00 to 110.00Hz	±2 dgt	Maximum input: 30 V Sensitivity: 0.5 Vp-p Input resistance: 100kΩ Contact input: Up to 100 Hz	
	1000Hz	0.1Hz	1.0 to 1100.0Hz			
	10kHz	0.001kHz	0.001 to 11.000kHz			
	CPM	1CPM	0 to 100000CPM			
	CPH	1CPH	0 to 100000CPH			
	CPH	1CPH	0 to 100000CPH			
Loop power supply	24V LOOP		24V±2V		Maximum load current: 22 mA	

Temperature coefficient: Accuracy above x (1/10)/°C

The temperature coefficient is added in the ranges from 0 to 18°C and from 28 to 40°C

General Specifications

Specifications common to source and measurement

Communication functions

Serial interface
RS232 D-Sub 9-pin connector

Memory functions

Data can be stored and loaded in setting memory (setting data) and data memory (source/measurement).

	Items stored/loaded	Number of data items that can be stored
Setting memory	(source/measurement) functions, ranges, generated values/measured values and setting mode conditions	21set
Data memory	Storage date/time, (source/measurement) functions, ranges and generated values/measured values	100set

Common source specifications

Power supply

6 AA size alkaline batteries
AC adapter (sold separately) or dedicated NiMH battery (sold separately)
AC adapter specification:
100 to 240 VAC, 50/60 Hz, 1.4 A
OUTPUT: 12 VDC, 3 A

Battery life Conditions:

Simultaneous Source/measurement
Output of 5 V DC/10 kΩ or more
Size AA alkaline batteries
When 6 batteries are used:
Approx. 8 hours

Auto power-off

When NiMH battery is used:
Approx. 10 hours
Approx. 10 minutes;
it can be canceled by setting.

Insulation resistance

Between input terminal and output terminal: 500 VDC, 50 MΩ or more

Withstand voltage

Between measurement terminal and generation terminal:
350 VAC, 1 minute

Operating temperature/humidity range:

0 to 40°C, 20 to 80%RH
(no condensation)

Storage temperature range:

-20 to 60°C 90%RH or less
(no condensation)

External dimensions:

Approx. 251 x 124 x 70 mm

Weight:

Approx. 1000 g

Accessories

Lead cable for generation: 1 set
Lead cable for measurement: 1 set
Carrying case: 1
Terminal adapter: 1
Size AA battery: 6
Instruction Manual: 1
Fuse for measurement: 1 (spare)

Conforming Standards

Safety EN61010-1
EMC EN 61326 Class B; EN 55011 Class B Group1
EN 61000-3-2; EN 61000-3-3, EN61326

Specifications common to source unit

- Source unit response time: Approx. 300 ms only ranges 1V, 10V, 500Ω (excitation current 1mA) and RTD (excitation current 1mA) response time approx. 5ms (the time from the point where the output starts to change to the point when it gets within the accuracy range)
- Source unit voltage limiter: Approx. 32 V
- Source unit current limiter: Approx. 25 mA
- Output polarity switching: enable
- Division output (n/m) function
Output = setting value x (n/m)
Steps can be set in the ranges of n = 0 to 19 and m = 1 to 19.
Condition: n/m
- Step sweep function
Automatic sweep of n values when the division (n/m) function is selected
It can be selected from the following options: 5 seconds, 10 seconds and step.
- Linear sweep function
Linear output function
The sweep time can be selected from the following options:
16 seconds and 32 seconds.
- Program sweep function
Outputs source values saved by the data memory function in the order the values are stored in memory.
Maximum step setting: 100 data
The output setting can be selected from the following options: 5 seconds, 10 seconds and step.

*1 Depending on the internal settings, either ITS-90 or IPTS-68 can be selected.

*4 The same ranges of frequencies and

● Model Name

Product name	Model name
Handy Calibrator	CA150

With the main body case (model name: 93027)
(sold separately) installed
Includes strap and accessory storage case



The main body case is designed to make it easy to hold with one hand.

● External Dimensions

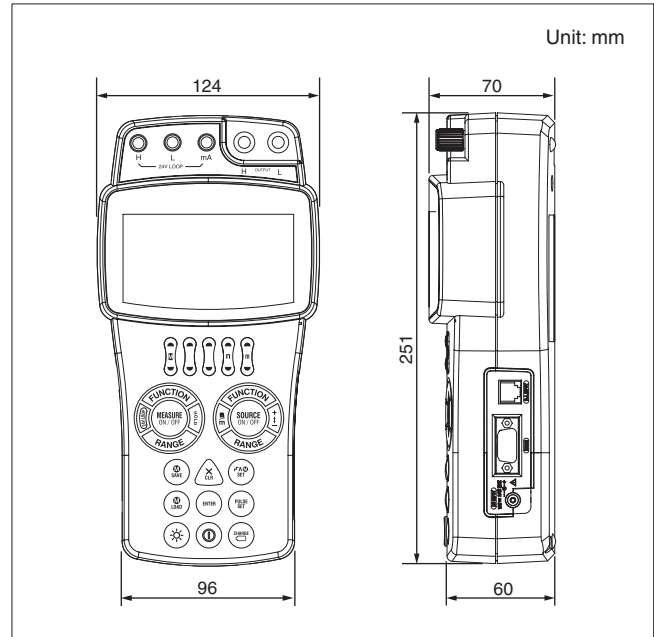

● Supplied Accessories

Product name	Lead cable for source	Lead cable for measurement	Carrying case	Terminal adapter
Model name	98020	RD031	93026	99022
Remark	One set of 1 red and 2 black cables Length: Approx. 1.7 m	One set of 1 red and 1 black cables Length: Approx. 1.0 m	Lead cables for source/measurement, terminal adapter, 6 spare batteries, fuse, AC adapter and instruction Manual can be stored.	Used for temperature measurement.

● Optional Accessories (sold separately)

Product name	AC adapter	RJ sensor	Accessory storage case	NiMH battery	Main body case
Model name	94010	B9108WA	B9108XA	94015	93027
Remark	-D For UL/CSA Standard -F For VDE Standard -H For GB Standard -R For SAA Standard -S For BS Standard	For reference junction compensation	Lead cables, RJ sensor, etc. can be stored.	NiMH battery Dedicated	With strap and accessory storage case

YOKOGAWA 
Yokogawa Meters & Instruments Corporation

World Wide Web site at
<http://www.yokogawa.com/MCC>

⚠ NOTICE

- Before using the product, read the instruction manual carefully to ensure proper and safe operation.

YOKOGAWA METERS & INSTRUMENTS CORPORATION Tachih Bld. No.2, 6-1-3 Sakaecho, Tachikawa-shi, Tokyo, 190-8586 Japan
International Sales Dept. Phone: +81-42-534-1413 Facsimile: +81-42-534-1426

YOKOGAWA CORPORATION OF AMERICA (U.S.A.)
YOKOGAWA EUROPE B. V. (THE NETHERLANDS)
YOKOGAWA ENGINEERING ASIA PTE. LTD. (SINGAPORE)
YOKOGAWA AMERICA DO SUL LTDA (BRAZIL)
YOKOGAWA MEASURING INSTRUMENTS KOREA CORPORATION (KOREA)
YOKOGAWA AUSTRALIA PTY. LTD. (AUSTRALIA)
YOKOGAWA INDIA LTD. (INDIA)
YOKOGAWA SHANGHAI TRADING CO., LTD. (CHINA)
YOKOGAWA MIDDLE EAST E.C. (BAHRAIN)
YOKOGAWA ELECTRIC CIS LTD. (RUSSIAN FEDERATION)

Phone: +1-770-253-7000
Phone: +31-334-64-1611
Phone: +65-6241-9933
Phone: +55-11-5681-2400
Phone: +82-2-551-0660
Phone: +61-2-8870-1100
Phone: +91-80-4158-6000
Phone: +86-21-6880-8107
Phone: +973-358100
Phone: +7-095-737-7868

Facsimile: +1-770-251-2088
Facsimile: +31-334-64-1610
Facsimile: +65-6241-2606
Facsimile: +55-11-5681-1274/4434
Facsimile: +82-2-551-0665
Facsimile: +61-2-8870-1111
Facsimile: +91-80-2852-1441
Facsimile: +86-21-6880-4987
Facsimile: +973-336100
Facsimile: +7-095-737-7869

Represented by:

MIK-ES15